

# SD230

## Industrial Diesel Generator Set

EPA Certified Stationary Emergency

Standby Power Rating  
**288kVA 230kW 60Hz**

Prime Power Rating\*  
**259kVA 207kW 60Hz**

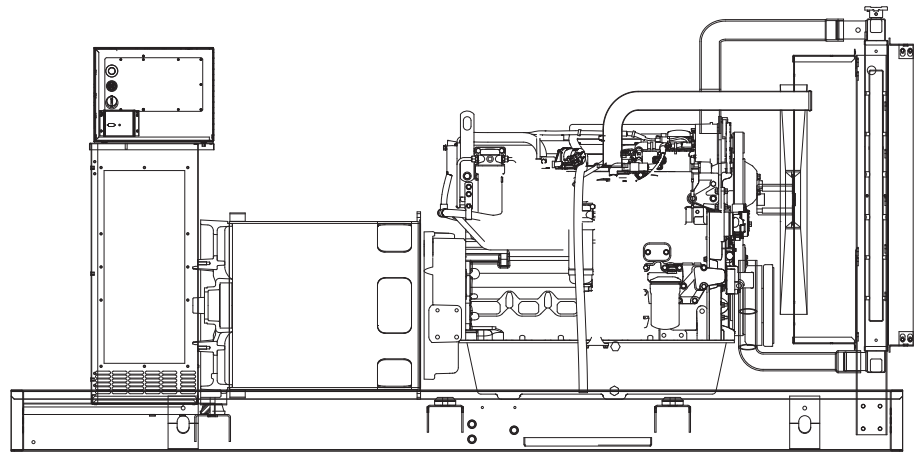

Generator image used for illustration purposes only

\*EPA Certified Prime ratings are not available in the U.S. or its Territories for engine model year 2011 and beyond

### features

### benefits

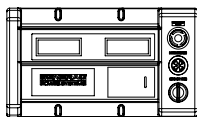
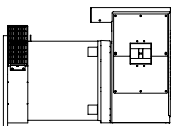
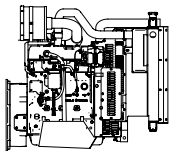
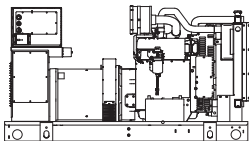

#### Generator Set

- PROTOTYPE & TORSIONALLY TESTED
- UL2200 TESTED
- RHINOCOAT PAINT SYSTEM
- WIDE RANGE OF ENCLOSURES AND TANKS
- ▶ PROVIDES A PROVEN UNIT
- ▶ ENSURES A QUALITY PRODUCT
- ▶ IMPROVES RESISTANCE TO ELEMENTS
- ▶ PROVIDES A SINGLE SOURCE SOLUTION

#### Engine

- EPA COMPLIANT
- INDUSTRIAL TESTED, GENERAC APPROVED
- POWER-MATCHED OUTPUT
- INDUSTRIAL GRADE
- ▶ ENVIRONMENTALLY FRIENDLY
- ▶ ENSURES INDUSTRIAL STANDARDS
- ▶ ENGINEERED FOR PERFORMANCE
- ▶ IMPROVES LONGEVITY AND RELIABILITY

#### Alternator

- TWO-THIRDS PITCH
- LAYER WOUND ROTOR & STATOR
- CLASS H MATERIALS
- DIGITAL 3-PHASE VOLTAGE CONTROL
- ▶ ELIMINATES HARMFUL 3RD HARMONIC
- ▶ IMPROVES COOLING
- ▶ HEAT TOLERANT DESIGN
- ▶ FAST AND ACCURATE RESPONSE

#### Controls

- ENCAPSULATED BOARD W/ SEALED HARNESS
- 4-20mA VOLTAGE-TO-CURRENT SENSORS
- SURFACE-MOUNT TECHNOLOGY
- ADVANCED DIAGNOSTICS & COMMUNICATIONS
- ▶ EASY, AFFORDABLE REPLACEMENT
- ▶ NOISE RESISTANT 24/7 MONITORING
- ▶ PROVIDES VIBRATION RESISTANCE
- ▶ HARDENED RELIABILITY

### primary codes and standards



## SD230

## application and engineering data

## ENGINE SPECIFICATIONS

**General**

Make	Iveco/FPT
EPA Emissions Compliance	Stationary Emergency
EPA Emissions Reference	See Emissions Data Sheet
Cylinder #	6
Type	In-Line
Displacement - L	8.7
Bore - mm (in.)	117 (4.61)
Stroke - mm (in.)	135 (5.31)
Compression Ratio	16.5:1
Intake Air Method	Turbocharged/Aftercooled
Cylinder Head Type	4- Valve
Piston Type	Aluminum
Crankshaft Type	Dropped Forged Steel

**Engine Governing**

Governor	Electronic Isochronous
Frequency Regulation (Steady State)	± 0.25%

**Lubrication System**

Oil Pump Type	Gear
Oil Filter Type	Full-Flow
Crankcase Capacity - L (qts)	28 (29.57)

**Cooling System**

Cooling System Type	Closed Recovery
Water Pump Flow	Pre-Lubed, Self Sealing
Fan Type	Pusher
Fan Speed (rpm)	2538 rpm
Fan Diameter mm (in.)	762 (30.0)
Coolant Heater Wattage	2000
Coolant Heater Standard Voltage	240VAC

**Fuel System**

Fuel Type	Ultra Low Sulfur Diesel Fuel
Fuel Specifications	ASTM
Fuel Filtering (microns)	5
Fuel Inject Pump Make	Electronic
Fuel Pump Type	Engine Driven Gear
Injector Type	Common Rail
Engine Type	Direct Injection
Fuel Supply Line - mm (in.)	12.7 (½")
Fuel Return Line - mm (in.)	12.7 (½")

**Engine Electrical System**

System Voltage	24VDC
Battery Charging Alternator	Std
Battery Size (at 0°C)	995 CCA
Battery Group	31
Battery Voltage	(2) - 12VDC
Ground Polarity	Negative

## ALTERNATOR SPECIFICATIONS

Standard Model	520 mm Generac
Poles	4
Field Type	Revolving
Insulation Class - Rotor	H
Insulation Class - Stator	H
Total Harmonic Distortion	< 5%
Telephone Interference Factor (TIF)	< 50
Standard Excitation	Permanent Magnent
Bearings	Single Sealed Cartridge
Coupling	Direct, Flexible Disc
Load Capacity - Standby	100%
Prototype Short Circuit Test	Yes

Voltage Regulator Type	Digital
Number of Sensed Phases	All
Regulation Accuracy (Steady State)	± 0.25%

## CODES AND STANDARDS COMPLIANCE (WHERE APPLICABLE)

NFPA 99	BS5514
NFPA 110	SAE J1349
ISO 8528-5	DIN6271
ISO 1708A.5	IEEE C62.41 TESTING
ISO 3046	NEMA ICS 1

## Rating Definitions:

Standby – Applicable for a varying emergency load for the duration of a utility power outage with no overload capability. (Max. load factor = 70%)

Prime – Applicable for supplying power to a varying load in lieu of utility for an unlimited amount of running time. (Max. load factor = 80%) A 10% overload capacity is available for 1 out of every 12 hours.

# SD230

# operating data (60Hz)

## POWER RATINGS (kW)

	STANDBY		PRIME	
Single-Phase 120/240VAC @1.0pf	230 kW	Amps: 958	207 kW	Amps: 863
Three-Phase 120/208VAC @0.8pf	230 kW	Amps: 798	207 kW	Amps: 718
Three-Phase 120/240VAC @0.8pf	230 kW	Amps: 692	207 kW	Amps: 622
Three-Phase 277/480VAC @0.8pf	230 kW	Amps: 346	207 kW	Amps: 311
Three-Phase 346/600VAC @0.8pf	230 kW	Amps: 277	207 kW	Amps: 249

## STARTING CAPABILITIES (sKVA)

### sKVA vs. Voltage Dip

Alternator	kW	480VAC						208/240VAC					
		10%	15%	20%	25%	30%	35%	10%	15%	20%	25%	30%	35%
Standard	250	263	395	527	658	790	922	197	296	395	494	593	692
Upsize 1	300	303	454	605	757	908	1059	227	341	454	568	681	794
Upsize 2	350	383	575	767	958	1150	1342	280	410	535	640	770	900

## FUEL

### Fuel Consumption Rates\*

		STANDBY			PRIME		
		Percent Load	gph	lph	Percent Load	gph	lph
Fuel Pump Lift - in (mm)	36 (900)						
Total Fuel Requirement Capacity - lph (gph)	98 (26)						
		25%	5.1	19.3	25%	4.7	17.8
		50%	9.6	36.3	50%	8.8	33.3
		75%	13.7	51.9	75%	12.6	47.7
		100%	17	64.3	100%	15.6	59.0

\* Refer to "Emissions Data Sheet" for maximum fuel flow for EPA and SCAQMD permitting purposes.

## COOLING

		STANDBY	PRIME
Coolant Flow per Minute	gpm (lpm)	63.3 (240)	63.3 (240)
Heat Rejection to Coolant	BTU/hr	626,756	575,141
Inlet Air	cfm (m3/min)	8,872 (251)	8,872 (251)
Max. Operating Radiator Air Temp	F° (C°)	122 (50)	122 (50)
Max. Operating Ambient Temperature	F° (C°)	104 (40)	104 (40)
Coolant System Capacity	gal (L)	12.7 (49.2)	12.7 (49.2)
Maximum Radiator Backpressure	in H <sub>2</sub> O	1.5	1.5

## COMBUSTION AIR REQUIREMENTS

		STANDBY	PRIME
Flow at Rated Power	cfm (m3/min)	660 (18.69)	594 (16.82)

## ENGINE

		STANDBY	PRIME
Rated Engine Speed	rpm	1800	1800
Horsepower at Rated kW**	hp	359	323
Piston Speed	ft/min	1593	1593
BMEP	psi	305	275

\*\* Refer to "Emissions Data Sheet" for maximum bHP for EPA and SCAQMD permitting purposes.

## EXHAUST

		STANDBY	PRIME
Exhaust Flow (Rated Output)	cfm (m³/min)	1,426 (40.4)	1,354 (38.3)
Max. Backpressure (Post Silencer)	inHg (Kpa)	1.5 (5.1)	1.5 (5.1)
Exhaust Temp (Rated Output)	°F (°C)	955 (513)	860 (460)
Exhaust Outlet Size (Open Set)	NPT (male)	101.6 (4)	101.6 (4)

Deration – Operational characteristics consider maximum ambient conditions. Derate factors may apply under atypical site conditions. Please consult a Generac Power Systems Industrial Dealer for additional details. All performance ratings in accordance with ISO3046, BS5514, ISO8528 and DIN6271 standards.

# SD230

## standard features and options

### GENERATOR SET



- Genset Vibration Isolation Std
- IBC Seismic Certified/Seismic Rated Vibration Isolators Opt
- Extended warranty Opt
- Gen-Link Communications Software Opt
- Steel Enclosure Opt
- Aluminum Enclosure Opt

### ENGINE SYSTEM



#### General

- Oil Drain Extension Std
- Oil Make-Up System Opt
- Oil Heater Opt
- Air cleaner Std
- Fan guard Std
- Radiator duct adapter Std

#### Fuel System

- Fuel lockoff solenoid Std
- Secondary fuel filter Std
- Stainless steel flexible exhaust connection Std
- Industrial Exhaust Silencer Std
- Critical Exhaust Silencer Opt
- Flexible fuel lines Opt
- Primary fuel filter Opt
- Single Wall Tank (Export Only) -
- UL 142 Fuel Tank Opt

#### Cooling System

- 120VAC Coolant Heater Opt
- 208VAC Coolant Heater Opt
- 240VAC Coolant Heater Std
- Other Coolant Heater -
- Closed Coolant Recovery System Std
- UV/Ozone resistant hoses Std
- Factory-Installed Radiator Std
- Radiator Drain Extension Std

#### Engine Electrical System

- Battery charging alternator Std
- Battery cables Std
- Battery tray Std
- Battery box Opt
- Battery heater Opt
- Solenoid activated starter motor Std
- 10A UL float/equalize battery charger Opt
- Rubber-booted engine electrical connections Std

### ALTERNATOR SYSTEM



- UL2200 GENprotect™ Std
- Main Line Circuit Breaker Opt
- 2nd Circuit Breaker Opt
- 3rd Circuit Breaker -
- Alternator Upsizing Opt
- Anti-Condensation Heater Opt
- Tropical coating Opt
- Permanent Magnet Generator Std

### CONTROL SYSTEM



#### Control Panel

- Digital H Control Panel - Dual 4x20 Display Std
- Digital G-100 Control Panel - Touchscreen na
- Digital G-200 Paralleling Control Panel - Touchscreen na
- Programmable Crank Limiter Std
- 21-Light Remote Annunciator Opt
- Remote Relay Panel (8 or 16) Opt
- 7-Day Programmable Exerciser Std
- Special Applications Programmable PLC Std
- RS-232 Std
- RS-485 Std
- All-Phase Sensing DVR Std
- Full System Status Std
- Utility Monitoring (Req. H-Transfer Switch) Std
- 2-Wire Start Compatible Std
- Power Output (kW) Std
- Power Factor Std
- Reactive Power Std
- All phase AC Voltage Std
- All phase Currents Std
- Oil Pressure Std
- Coolant Temperature Std
- Coolant Level Std
- Oil Temperature Opt
- Fuel Pressure Std
- Engine Speed Std
- Battery Voltage Std
- Frequency Std
- Date/Time Fault History (Event Log) Std
- Low-Speed Exercise -
- Isochronous Governor Control Std
- 40deg C - 70deg C Operation Std
- Waterproof Plug-In Connectors Std
- Audible Alarms and Shutdowns Std
- Not in Auto (Flashing Light) Std
- Auto/Off/Manual Switch Std
- E-Stop (Red Mushroom-Type) Std
- Remote E-Stop (Break Glass-Type, Surface Mount) Opt
- Remote E-Stop (Red Mushroom-Type, Surface Mount) Opt
- Remote E-Stop (Red Mushroom-Type, Flush Mount) Opt
- NFPA 110 Level I and II (Programmable) Std
- Remote Communication - RS232 Std
- Remote Communication - Modem Opt
- Remote Communication - Ethernet Opt
- 10A Run Relay Opt

#### Alarms (Programmable Tolerances, Pre-Alarms and Shutdowns)

- Low Fuel Opt
- Oil Pressure (Pre-programmed Low Pressure Shutdown) Std
- Coolant Temperature (Pre-programmed High Temp Shutdown) Std
- Coolant Level (Pre-programmed Low Level Shutdown) Std
- Oil Temperature Std
- Engine Speed (Pre-programmed Overspeed Shutdown) Std
- Voltage (Pre-programmed Overvoltage Shutdown) Std
- Battery Voltage Std

#### Other Options

- 
- 
-

**SD230**

**dimensions, weights and sound levels**

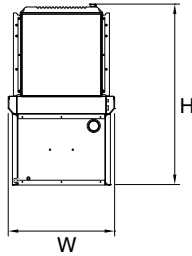
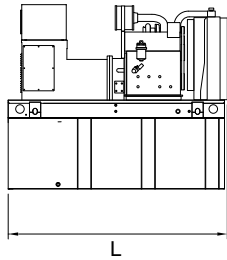

**OPEN SET**

RUN TIME HOURS	USABLE CAPACITY (GAL)	L	W	H	WT	dBA*
NO TANK	-	128	54	58	5016	87
9	153	128	54	71	6021	
22	372	128	54	83	6443	
34	589	128	54	95	6860	
40	693	136	54	95	6581	
55	946	208	54	99	8041	
78	1325	278	54	99	9056	

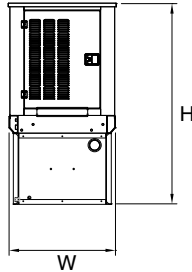
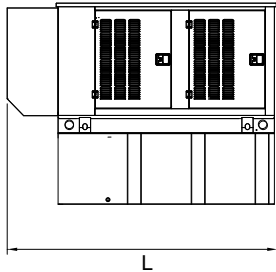

**WEATHERPROOF ENCLOSURE**

RUN TIME HOURS	USABLE CAPACITY (GAL)	L	W	H	WT	dBA*
NO TANK	-	155	54	70	6316	83
9	153	155	54	83	7321	
22	372	155	54	95	7743	
34	589	155	54	107	8160	
40	693	155	54	107	7881	
55	946	208	54	111	9341	
78	1325	278	54	111	10356	

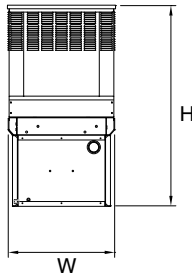
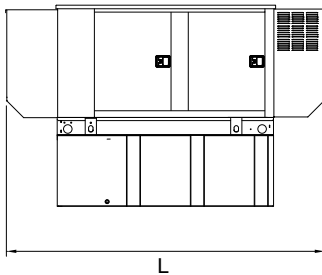

**LEVEL 1 SOUND ENCLOSURE**

RUN TIME HOURS	USABLE CAPACITY (GAL)	L	W	H	WT	dBA*
NO TANK	-	180	54	70	6820	76
9	153	180	54	83	7825	
22	372	180	54	95	8247	
34	589	180	54	107	8664	
40	693	180	54	107	8385	
55	946	234	54	111	9845	
78	1325	304	54	111	10860	

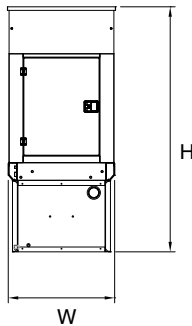
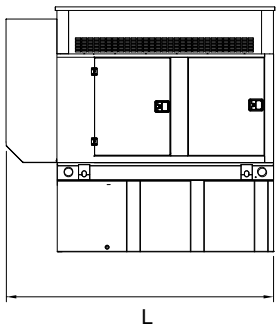

**LEVEL 2 SOUND ENCLOSURE**

RUN TIME HOURS	USABLE CAPACITY (GAL)	L	W	H	WT	dBA*
NO TANK	-	155	54	93	6663	74
9	153	155	54	106	7668	
22	372	155	54	118	8090	
34	589	155	54	130	8507	
40	693	155	54	130	8228	
55	946	208	54	132	9688	
78	1325	278	54	132	10703	

\*All measurements are approximate and for estimation purposes only. Weights are without fuel in tank. Sound levels measured at 23ft (7m) and does not account for ambient site conditions.

Tank Options

<input type="radio"/> MDEQ	OPT
<input type="radio"/> Florida DERM/DEP	OPT
<input type="radio"/> Chicago Fire Code	OPT
<input type="radio"/> IFC Certification	CALL
<input type="radio"/> ULC	CALL

Other Custom Options Available from your Generac Industrial Power Dealer

**YOUR FACTORY RECOGNIZED GENERAC INDUSTRIAL DEALER**

Specification characteristics may change without notice. Dimensions and weights are for preliminary purposes only. Please consult a Generac Power Systems Industrial Dealer for detailed installation drawings.